

SCHEINWERFERSCHUTZGITTER

Head light grille | Grille de phares | Griglia per i fari | Rejilla de los faros









Art.-Nr: 90260-002/102

DE Die Farben der Abbildungen dienen nur der Veranschaulichung.

EN The colors are for illustrating purposes only.

FR Les couleurs utilisées sont à titre indicatif seulement.

LEGENDE/KEY/FILE LÉGENDE

-  **Anbau Tipp**
Fitting tip
Astuce de montage
-  **Achtung**
Attention
Attention
-  **Vergrößerung**
Magnification
Grossissement
-  **Montagepaste**
Fitting lubricant
Lubrifiant de montage
-  **Schraube**
Screw
Vis
-  **Schraubensicherung**
Thread locking fluid
Freiniflets
-  **Drehmoment**
Torque
Torque
-  **Reiniger**
Cleaner
Nettoyant

BEZEICHNUNG / DESCRIPTION	DIN	ISO	
1 Halter unten (links-rechts) / Bracket below left and right side			2
2 Linienflanschschraube / Panhead screw M5 x 16	7381SA2	7381SA2	4
3 Rohrschelle / Pipe clamp			4
4 Blechmutter / Sheet metal nut			4
5 Sechskantmutter / Hexagon nut M5	985SA2		2
6 U-Scheibe A2 / Washer A2 M5	9021SA2	7093	2
7 U-Scheibe PA / Washer plastic DØ 14,5 -dØ 5,5mm	9021PA5	9021PA5	2
8 U-Scheibe PA / Washer plastic DØ 18,0 -dØ 6,4mm	9021PA5	9021PA5	2
9 Flachrundschraube / Round-head screw M5	603SA2	8677	2
10 Scheinwerferschutz / Head light grille			1
11 Snaplock Kupplung / Snaplock clutch			2
12 Snaplock Bolzen / Snaplock bolt			2
13 Halter oben (links-rechts) / Top bracket left and right side			2
14 U-Scheibe A2 / Washer A2 M6	125SA2	7089	2
15 Sechskantmutter / Hexagon nut M6			2
16 U-Scheibe KST / Washer plastic DØ 16,0 -dØ 8,4mm	125KST	7089	2
17 Schraubensicherung / Thread locking fluid			1
18 Lackschutzfolie / Protection film 20cm			4
19 Montagepaste / Fitting lubricant			1

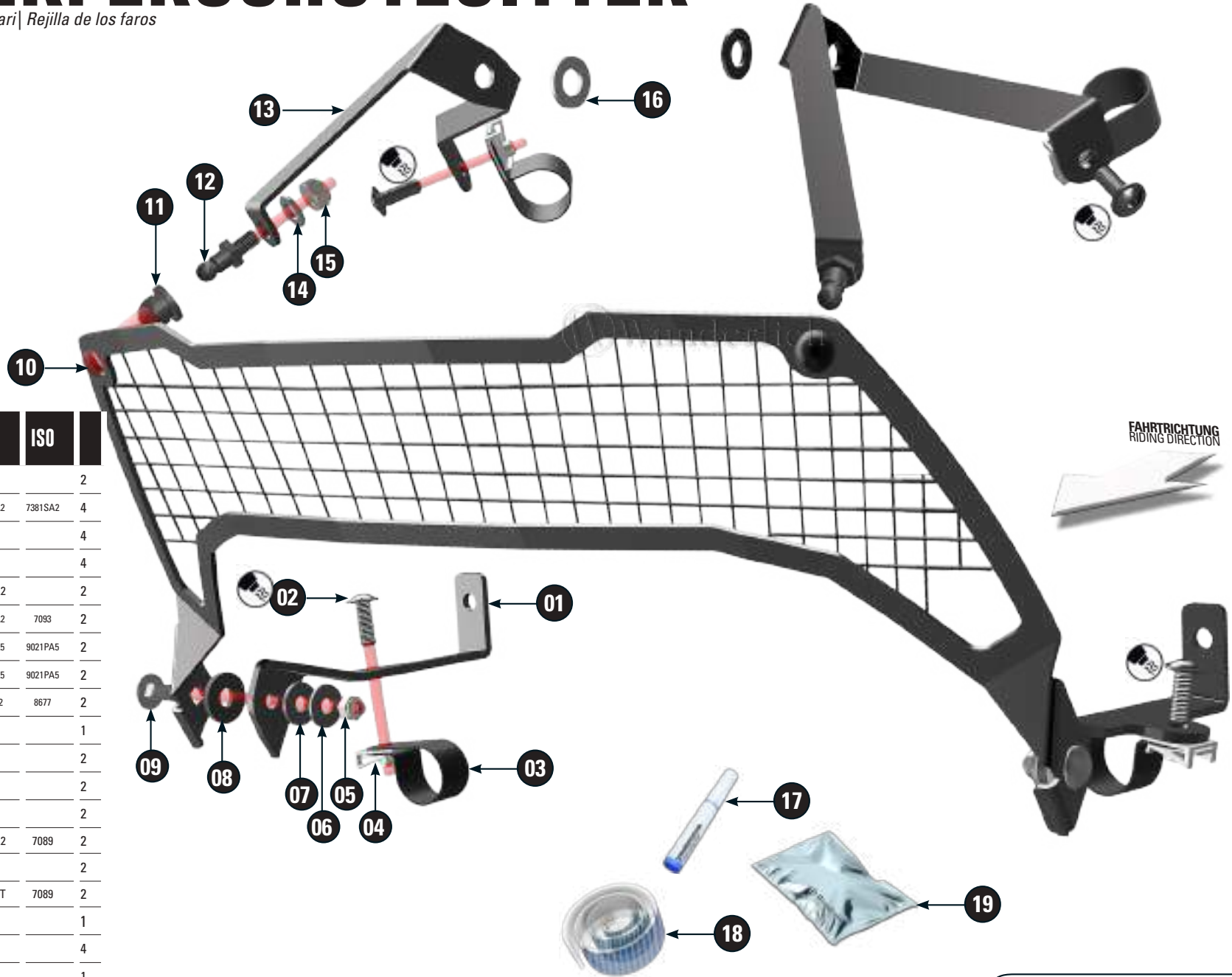



3 Lösen Sie immer nur eine Befestigung des Scheinwerfers, ansonsten sollte dieser wieder eingestellt werden.
Loosen only one attachment of the headlight at a time, otherwise it should be readjusted.
Ne desserrez qu'une seule fixation du phare à la fois, sinon il faudra le réajuster.

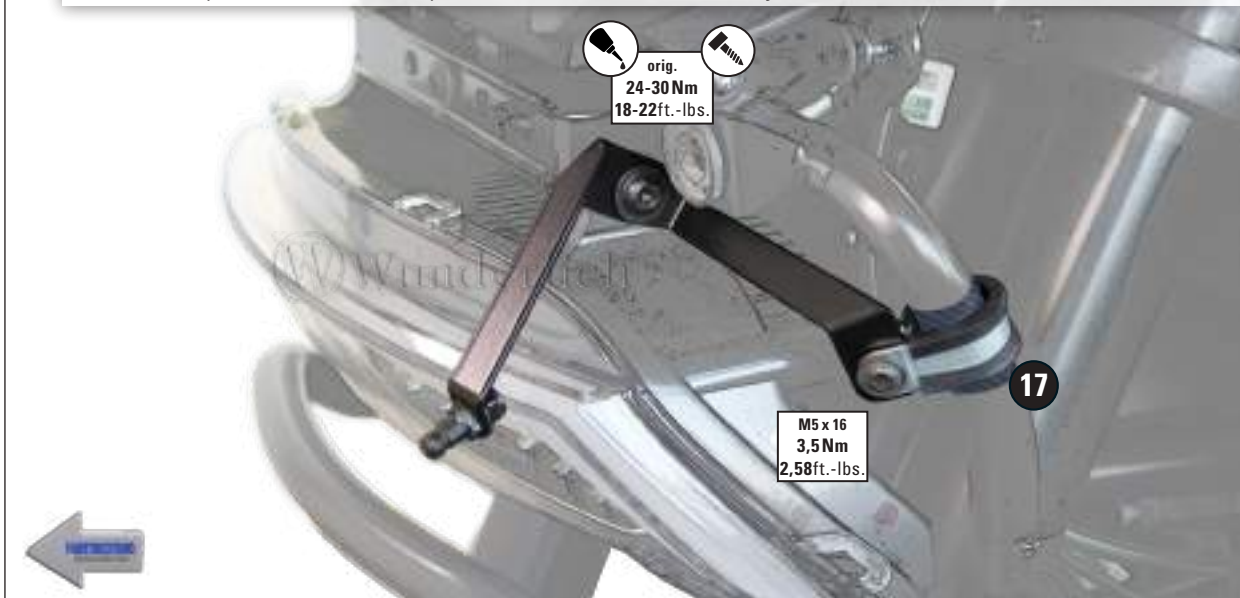

5

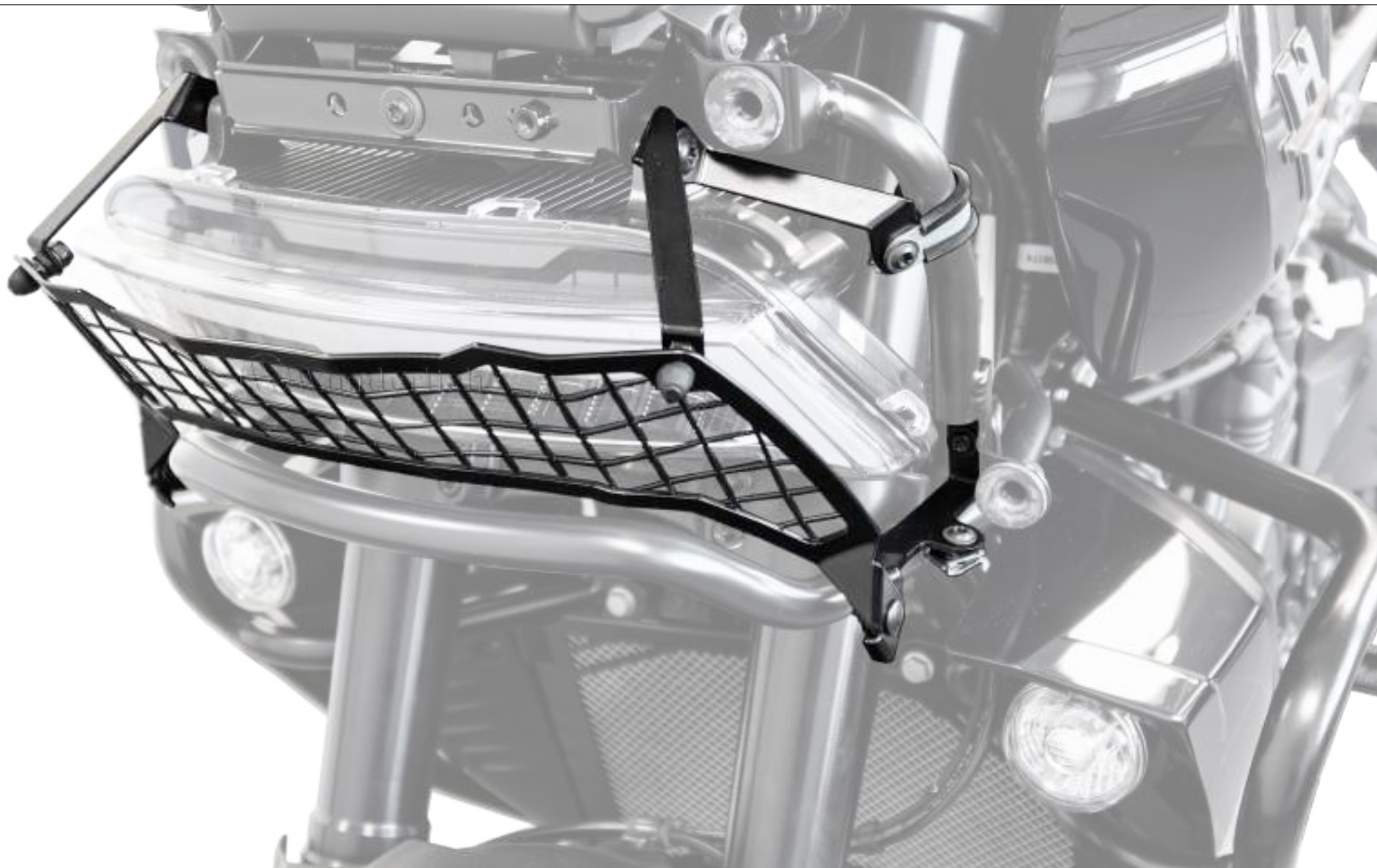

Scheinwerferschutz ausrichten und alle Schrauben festziehen. Danach die Verkleidung wieder aufstecken.

Align headlight grille and tighten all screws. Then put the cladding back on.

Alignez la grille des phares et serrez toutes les vis. Puis remettez le revêtement.

90260-002



90260-102



Die Montage von 90260-002 und 90260-102 ist identisch.
The assembly of 90260-002 and 90260-102 is identical.
L'assemblage du 90260-002 et du 90260-102 est identique.